

MIPRO®

MICROPHONE PROFESSIONALS

ACT-70T/ACT-52T/ACT-32T/

ACT-24T/ACT-58T

Two AA Batteries

ACT-70TC/ACT-52TC/ACT-32TC/

ACT-24TC/ACT-58TC

Rechargeable Lithium Battery

Bodypack Transmitters User Guide



ACT-70T ACT-52T ACT-32T ACT-24T ACT-58T



ACT-70TC ACT-52TC ACT-24TC ACT-58TC
ACT-32TC

I. Parts Name

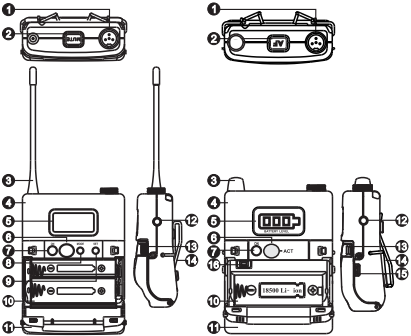

AA Battery (left); Rechargeable Battery (right)

- ❶ 4-Pin Microphone Input Jack
- ❷ Mute Button
- ❸ Transmitting Antenna (varies by different model)
- ❹ Housing
- ❺ LCD Panel
- ❻ ACT Sync Window
- ❼ Power Switch
- ❽ MODE button (ACT-70T/ACT-52T/ACT-32T/ACT-70TC/ACT-52TC/ACT-32TC)
- ❾ SET button (ACT-70T/ACT-52T/ACT-32T/ACT-70TC/ACT-52TC/ACT-32TC)
- ❿ Battery Compartment
- ⓫ Battery Cover
- ⓬ Remote control mute connector

- 13 Battery Cover Hooks
- 14 Reversible Belt Clip
- 15 Battery Charging Contact (ACT-70TC/ACT-52TC/ACT-32TC/ACT-58TC/ACT-24TC Rechargeable)
- 16 Battery protection circuit reset button (ACT-70TC/ACT-52TC/ACT-32TC Rechargeable)

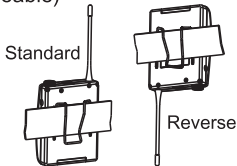

II. 4-Pin Microphone Input Jack Connection

1. Before turning on the power, connect the input signal source to the microphone input jacket ❶ first to avoid open-circuit induced noise.
2. Align and fasten the connector clockwise for a secured fit.

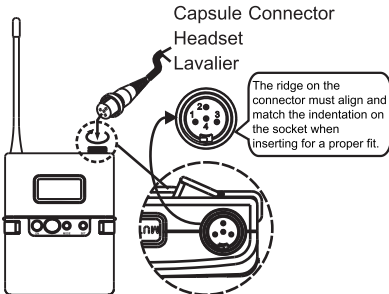

III. Operating Instructions

ACT-24T/ACT-24TC/ACT-58T/ACT-58TC:

1. Power On/Off: Press and hold Power button to turn on and turn off. The LED lights on after the device is powered on.

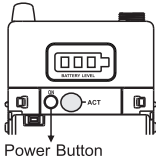

2. Battery level indicators: Recommend charging when single red indicator remains. Power shutdown automatically when battery voltage is too low.

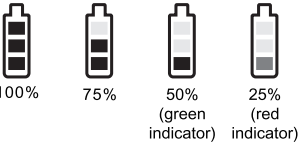

3. MUTE Button:

- (A) Press the MUTE button to enter mute status. The indicator is off, and the ACT function remains active.
- (B) Press again to unmute. The mute setting will be canceled automatically when power is off.
- (C) Lock: Power off, press and hold the MUTE button, and then power on. The indicator glows and the MUTE button is now inoperative.

Lock the MUTE button:

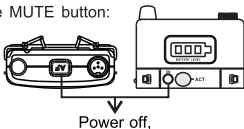

- 3 press and hold the MUTE button, and then power on

- (D) Disable Lock: Power off, press and hold the MUTE button, and power on to enable the MUTE button.

Disable Lock:

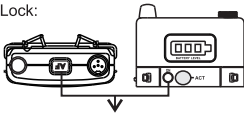

Power off,
press and hold the MUTE button, and then power on.

ACT-70T/ACT-70TC/ACT-52T/ACT-52TC/ ACT-32T/ACT-32TC :

1. Power On/Off:

- (A) Press and hold Power button to turn on and turn off. The LCD panel glows when power is on.

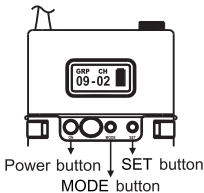

- (B) The LCD shows OFF... during turn-off.



2. Press MODE button **8** to select functions.
3. Press SET button **9** , and the parameter blinks, press SET button again to change the parameter.

4. **Battery Level Status:** Replace with a charged battery once the level falls to 10%. The device will power off automatically with an OFF message once the power level falls too low.

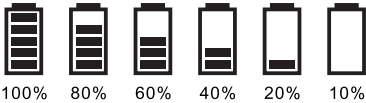

5. **LCD Screen:**

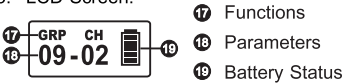

6. **LCD:**

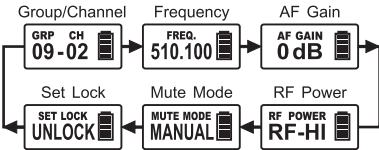

(A) GRP (Group) / CH (Channel) / FREQ. (Frequency):

- (1) Group / Channel / Frequency messages are displayed only and cannot be changed.
- (2) To change Group / Channel / Frequency, do it at the receiver and then press ACT button to sync.



- (3) For those specific channels set via PC, the screen shows only CHANNEL and numbers.



(B) AF Gain:

- (1) AF Gain can be changed from 12dB ~ -12dB, in 6dB steps.
- (2) The higher the AF Gain is, the lower the input signal of the dynamic range will be and it will increase noise and feedback chances.
- (3) Set AF Gain to -12dB for electric guitar.
- (4) 0dB is the factory default setting.



(C) RF POWER: Select RF-HI or RF-LOW.

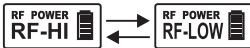

(D) MUTE MODE:

- (1) Select MANUAL or DISABLE.
- (2) MANUAL: Use MUTE button to mute/unmute.
- (3) DISABLE: MUTE button is disabled. Mute setting is canceled.



(E)SET LOCK:

- (1) Select LOCK or UNLOCK.
- (2) Under LOCK mode, settings cannot be changed including power on/off. To power off, it must be under unlock mode (UNLK). A sudden loss of power will disable LOCK.
- (3) MUTE function can be operated normally under LOCK mode.

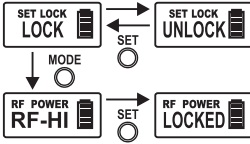

(F) Error Codes:

- (1) ERR no01 → Channel wasn't programmed or internal data error.
- (2) ERR no02 → Testing only.
- (3) ERR no03 → The set frequency exceeds the upper band. The microphone frequency will not be changed but it can be operated as long as the power switch is turned on again.
- (4) ERR no04 → The set frequency exceeds the lower band. The microphone frequency will not be changed but it can be operated as long as the power switch is turned on again.

(G)GROUP and CHANNEL are internal programmed channels.

(H)CHANNEL displays only (GROUP is not shown) indicates a user-defined frequency synced from receiver and it only can be changed via PC.

(I) MUTE Button:

- (1) MUTE button is only workable under MANUAL mode. Press MUTE button to enter mute status.
- (2) Press MODE and SET buttons to select parameters. Idle for 5 seconds and return to MUTE mode.
- (3) Press MUTE button again to unmute.
- (4) Unmute Mode: The screen shows UNMUTE for 1 second and returns to Home Screen.

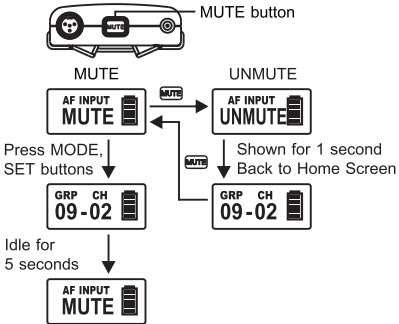

IV. High-frequency Noise Interference

High-frequency noise interference produces continuous high-frequency noise, which deteriorates sound quality. All MIPRO microphone capsule modules have a high-frequency noise interference prevention design. High-frequency noise interference may occur when other brands' microphone capsules are plugged into MIPRO transmitters.

V. Other Operations

1. Remote Control Mute Connector:
3.5 Ø Remote Control Mute Connector is for accepting MJ-70 Remote Mute Switch Cable.
2. Remote Mute Switch (Optional):
Plug MJ-70 Remote Mute Switch into Remote Control Mute Connector  before powering on.

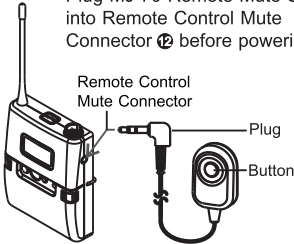

VI. AA Battery Insertion and Replacement

1. Press the side hooks to open battery compartment. Remove the battery carefully.
2. Insert two AA batteries according to correct polarity.
3. Power off to conserve battery power. Remove the battery when it will not be used for extended periods of time.

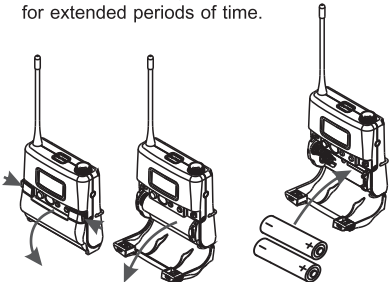

VII. Rechargeable Battery Insertion and Replacement

1. Press the side hooks to open battery compartment. Remove the battery carefully.
2. Insert one 18500 type lithium battery according to correct polarity.

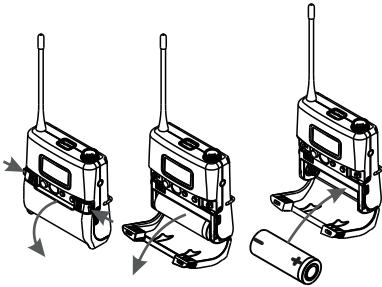

3. Power off to conserve battery power. Remove the battery when it will not be used for extended periods of time.
4. We recommend transmitter to be recharged directly in the docking battery charger.
5. Check battery polarity was inserted correctly if battery power is sufficient but unable to turn on the transmitter. Battery protection circuit is activated if correct battery polarity. Below methods are available to bypass the battery circuit protection:
 - (A) Insert the transmitter into the single or dual-docking battery charger for at least 10 seconds. Power on the transmitter.
 - (B) Insert battery with incorrect polarity first. Remove and re-insert again with correct polarity.

- (C) ACT-70TC/ACT-52TC/ACT-32TC: Open battery compartment, press the battery protection circuit reset button. Power on the transmitter.

Battery protection
circuit reset button

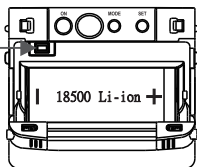

VIII. Transmitter Battery Chargers (optional)

ACT-70TC/ACT-52TC/ACT-32TC/ACT-58TC/
ACT-24TC:

Transmitter(s) can be inserted into MP-8 single-docking or dual-docking battery chargers.



Bodypack transmitter is
charging in a MP-8.

IX. Notes

1. Refer to the actual product in the event of product description discrepancy.
2. Frequency range and maximum deviation comply with the regulations of different countries.
3. Spraying alcohol directly onto the condenser capsule module will cause severe damage and invalidate the warranty.

X. 4-Pin Microphone Input Jack Wiring



1. 2-wire electret condenser microphone capsule connection:

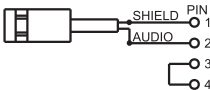

2. 3-wire electret condenser microphone capsule connection:

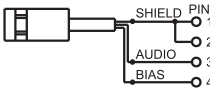

3. Dynamic Microphone:

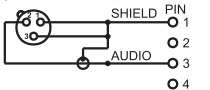

4. Electric Guitar:

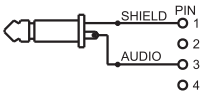

5. Line-input (impedance 8K ATT 10dB):

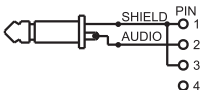

FCC

FCC Caution: To assure continued compliance, any changes or modifications not expressly approved by the party responsible for compliance could void the user's authority to operate this equipment. (Example - use only shielded interface cables when connecting to computer or peripheral devices).

This device complies with Part 15 of the FCC Rules. Operation is subject to the following two conditions:

- (1) This device may not cause harmful interference, and
- (2) This device must accept any interference received, including interference that may cause undesired operation.

This device complied with FCC radiation exposure limits as set forth for an uncontrolled environment. This device should be installed and operated so that its antenna(s) are not co-located or operating in conjunction with any other antenna or transmitter.

IC

This device complies with Industry Canada's RSSs. Operation is subject to the following two conditions:

- (1) This device may not cause interference; and
- (2) This device must accept any interference, including interference that may cause undesired operation of the device.

Le présent appareil est conforme aux CNR d'Industrie Canada applicables aux appareils radio. L'exploitation est autorisée aux deux conditions suivantes :

- (1) l'appareil ne doit pas produire de brouillage;
- (2) l'utilisateur de l'appareil doit accepter tout brouillage radioélectrique subi, même si le brouillage est susceptible d'en compromettre le fonctionnement.

Federal Communication Commission Interference Statement

This equipment has been tested and found to comply with the limits for a Class B digital device, pursuant to Part 15 of the FCC Rules. These limits are designed to provide reasonable protection against harmful interference in a residential installation.

This equipment generates, uses and can radiate radio frequency energy and, if not installed and used in accordance with the instructions, may cause harmful interference to radio communications. However, there is no guarantee that interference will not occur in a particular installation. If this equipment does cause harmful interference to radio or television reception, which can be determined by turning the equipment off and on, the user is encouraged to try to correct the interference by one of the following measures:

- Reorient or relocate the receiving antenna.
- Increase the separation between the equipment and receiver.
- Connect the equipment into an outlet on a circuit different from that to which the receiver is connected.
- Consult the dealer or an experienced radio/TV technician for help.

FCC Caution: To assure continued compliance, any changes or modifications not expressly approved by the party responsible for compliance could void the user's authority to operate this equipment. (Example - use only shielded interface cables when connecting to computer or peripheral devices).

FCC Radiation Exposure Statement

This equipment complies with FCC RF radiation exposure limits set forth for an uncontrolled environment.

This transmitter must not be co-located or operating in conjunction with any other antenna or transmitter.

This device complies with Part 15 of the FCC Rules. Operation is subject to the following two conditions:

- (1) This device may not cause harmful interference, and
- (2) This device must accept any interference received, including interference that may cause undesired operation.

Industry Canada Statement

This device complies with Industry Canada licence-exempt RSS standard.

Operation is subject to the following two conditions:

- (1) this device may not cause interference, and
- (2) this device must accept any interference, including interference that may cause undesired operation of the device.

Le présent appareil est conforme aux CNR d'Industrie Canada applicables aux appareils radio exempts de licence.

L'exploitation est autorisée aux deux conditions suivantes :

- (1) l'appareil ne doit pas produire de brouillage, et (2) l'utilisateur de l'appareil doit accepter tout brouillage radioélectrique subi, même si le brouillage est susceptible d'en compromettre le fonctionnement.

IC Radiation Exposure Statement:

This equipment complies with IC RSS-102 radiation exposure limit set forth for an uncontrolled environment.

Cet équipement est conforme aux CNR-102 d'Industrie Canada.

MIPRO[®]
MICROPHONE PROFESSIONALS



All rights reserved. Do not copy or forward without prior approvals of MIPRO. Specifications and design subject to change without notice. YM 023/01

MIPRO Electronics Co., Ltd

Headquarters: No. 814, Beigang Rd., Chiayi City 600079, Taiwan
Tel : +886.5.238.0809 Fax : +886.5.238.0803
www.mipro.com.tw mipro@mipro.com.tw



2 CE6 12 F